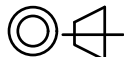
	Description: D2401-P		Material: PCB
Scale 1:1mm	General Tolerances: +/-0.5mm	Projection: 	Date: 24/03/2021 Version No: 20

Mains Connection

LED

Live

Earth

Neutral

M3 x 6 mm panhead
recommended with 10
mm high
hex stand off

External LED

+/- 24V

PSU/Fault Output

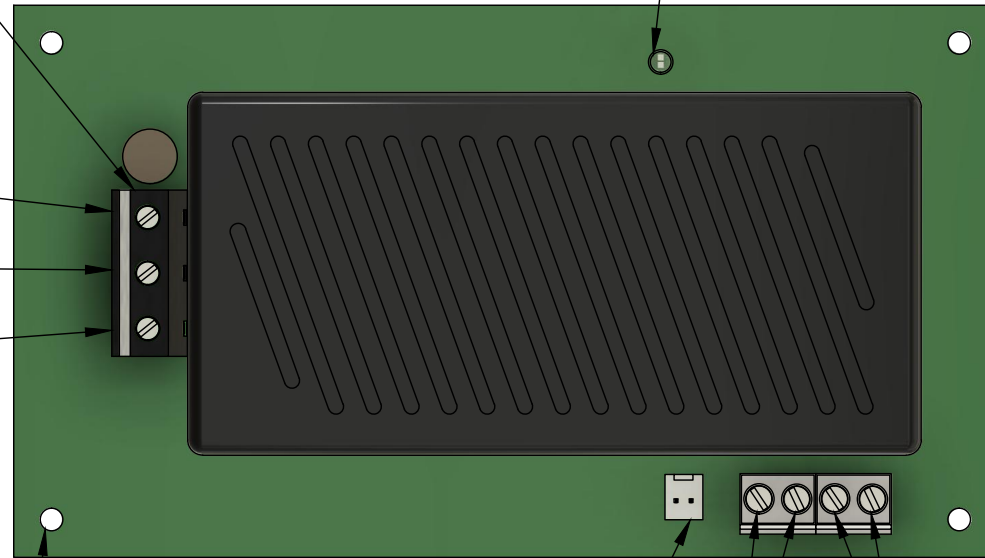

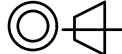
	Description: D2401-P		Material: PCB
Scale 1:1mm	General Tolerances: +/-0.5mm	Projection: 	Date: 24/03/2021 Version No: 20

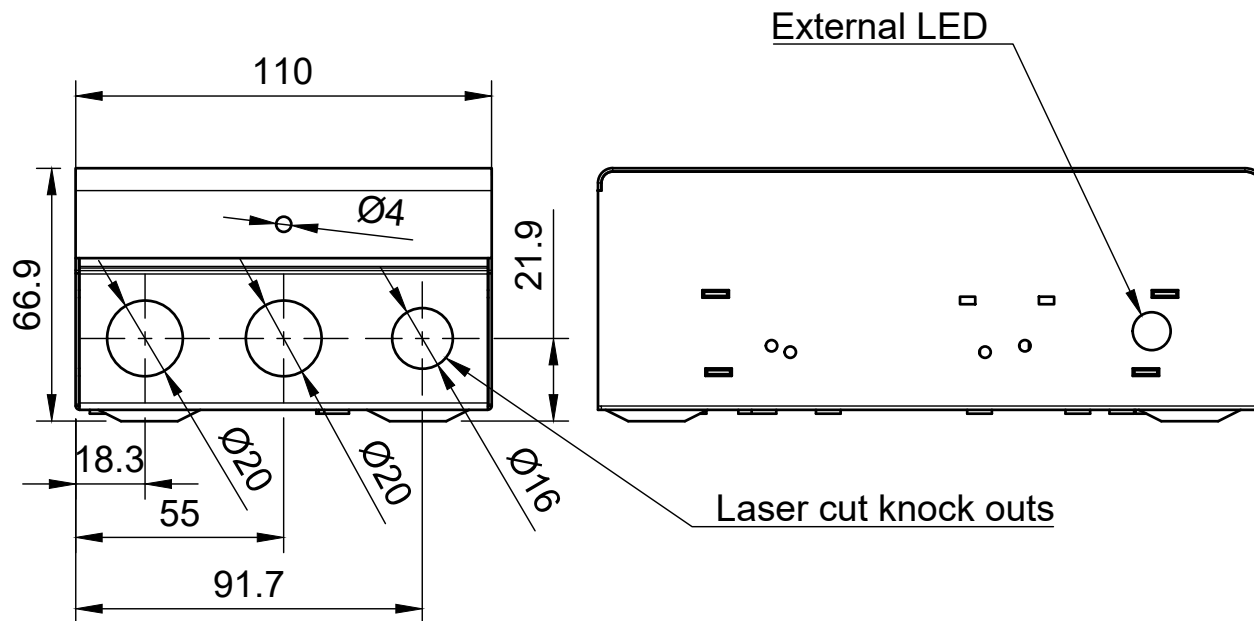
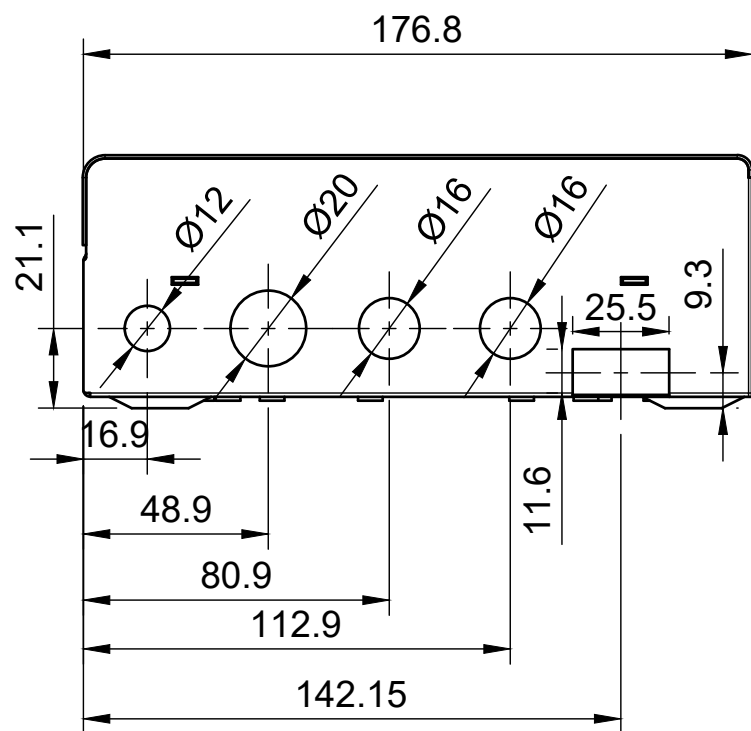

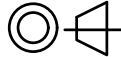
 DYCON power solutions	Description: AA Box		Material: Steel
Scale 1:3mm	General Tolerances: +/-0.5mm	Projection: 	Date: 09/04/2021 Version:5

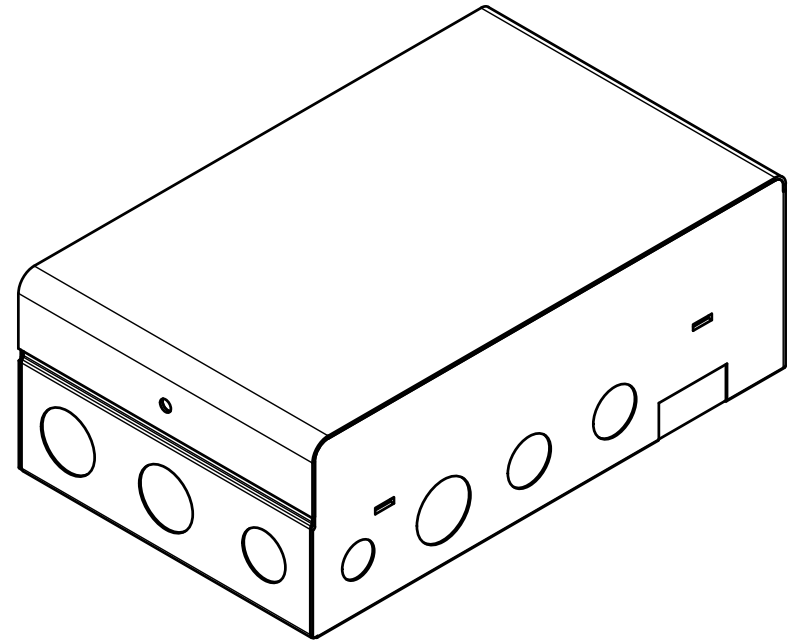
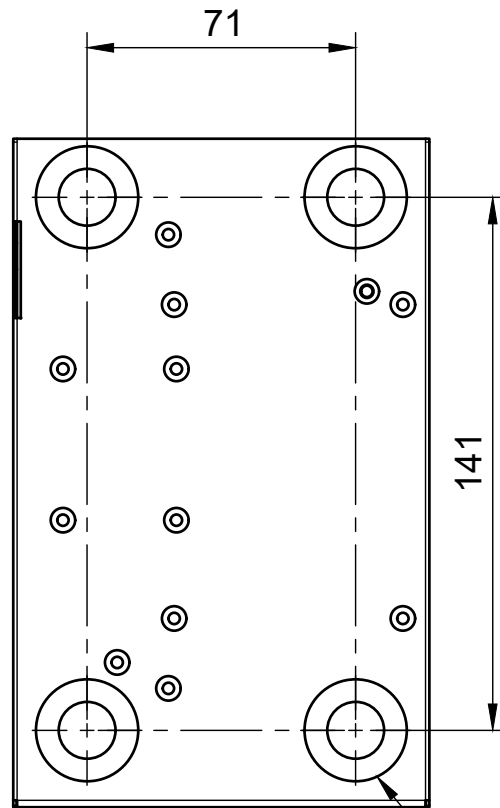
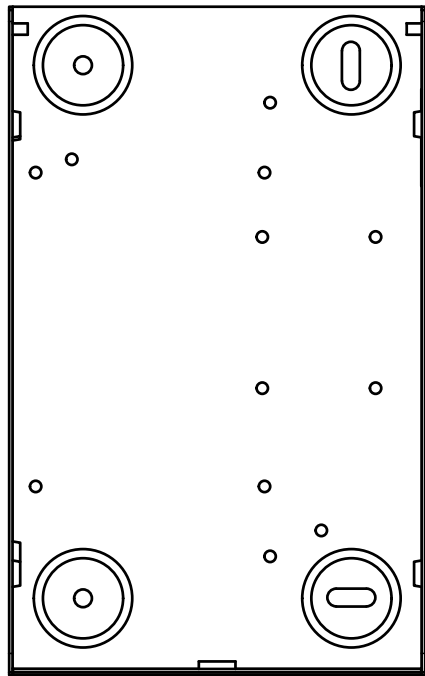

Mounting dimples

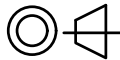
 <p>DYCON power solutions</p>	Description: AA Box		Material: Steel
Scale 1:3mm	General Tolerances: +-0.5mm	Projection: 	Date: 09/04/2021 Version:5